



craftplus®

MACHINERY 2019



CRAFTSMANSHIP BEGINS WITH THE RIGHT TOOL

Craftplus is an award winning tool brand known for its clever products that solves leather craft problems through design. We design tools that change the way people work; saving steps, improving quality and enhancing safety.



TABLE OF CONTENTS



4
Hot Stamp & Foil Imprinter



10
Bench Burnisher



18
Tipping Machine



24
Clicker Press



30
Rotary Strap Cutter



34
Edge Dyeing Machine



40
Multi-Purpose
Leather Hand Press

EXPAND YOUR CRAFTPLUS EXPERIENCE ONLINE

Go online to view expanded details and videos of each product listed in this catalog. There are also set up videos so you can start working faster. And if you want to see our latest and greatest tools, sign up for new tool alerts.

craftplus.com





craftplus
ITEM NUMBER: 3970-00
MODEL: HOT STAMP AND FOIL IMPRINTER SERIAL NO.:
POWER: 110V AC 60HZ 250W TEMPERATURE: 0°C-300 °C
RECOMMENDED SETTING
GENERAL FOIL TEMPERATURE: -120°C
GENERAL STAMP TEMPERATURE: -150°C
RESULTS MAY VARY ACCORDING TO FOIL & LEATHER
TEST TEMPERATURE BEFORE PROCEEDING
WARNING
DISTRIBUTED BY
IVAN LEATHERCRAFT CO., LTD.
WWW.IVAN.TW
MADE IN CHINA

HOT STAMP & FOIL IMPRINTER

3970-00

- Designed for heat embossing and foil application, comes with solid brass I- line type holders (2)
- User friendly, versatile for hot stamp & foil imprint needs
- Small foot print takes up less space
- Quickly and easily customize your own leather goods
- Works on wide range of leather types
- US, UK, EU & AU models available



PRODUCT SPECIFICATIONS

Item No.	3970-00
Power Consumption	110V AC 60HZ (US) 230V AC 50HZ (AU) 220/240V AC 50HZ (UK/EU)
Dimensions	21 X 35 X 50 cm (8.2" X 13.7" X 19.6")
Weight	12 KG (26.5 LBS)
Packaging	44 X 38 X 31 cm (17.3" X 15" X 12.2")
Gross Weight	15 KG (33 LBS)

Features



Digital Temperature Controller

Digital heat control, temperature output up to 300 degree Celsius, makes hot stamp or foil imprint accurate and easy.



Table That Travels The Distance

14 X14.5 cm (5-1/2" X 5-3/4") pull out table with 6mm (1/4") alignment grid, providing accurate work placement and safer work access.

MORE DETAILS

 VIDEO AVAILABLE



Get A Boost With Dual Type Holders

No long cool down time, pick up second type holder and start your work. Reduce down time.

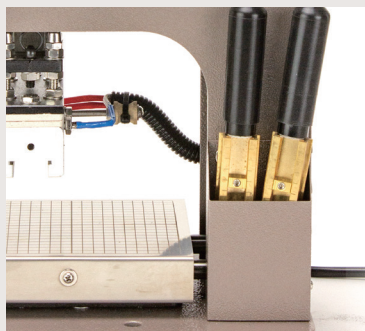

Safety. Priority

Keep your work and yourself out of harm's way. Store and switch out type holders, carry out two projects simultaneously.









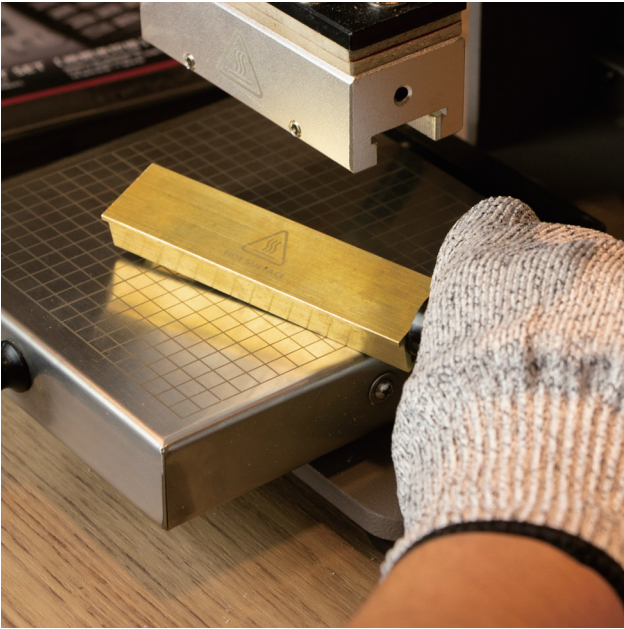

Freedom To Create Letter Combinations

Solid brass 1-line type holder that holds 4.5mm (3/16") and 6mm (1/4") letters. Simple changeover, letters can be mounted and removed in seconds, giving your great freedom to customize any leather goods. (Brass imprint set sold separately.)





HOT STAMP & FOIL IMPRINTER ACCESSORIES

Hot Stamp	4.5mm (3/16") Brass Imprint Set		Includes letters (67), numbers (30), symbols (28) & spacers (17)	142 pcs	3970-10
	6mm (1/4") Brass Imprint Set			142 pcs	3970-11
	Solid Brass I-Line Type Holder		Hot Stamp & Foil Imprinter Type Holder, for use with 4.5mm (3/16") and 6mm (1/4") Brass Imprinting Set	1 pc	3970-50
	Heat Tube		Hot Stamp & Foil Imprinter replacement heat tube	1 pc	3970-51
Made To Order	Multi Use Custom Stamp		Solid brass embossing plate with stamp adapter. Stamp adapter allows the plate to be used on 3960-00 Multi-Purpose Leather Hand Press. Artwork required for your custom order. Maximum logo design: 38mm (1-1/2") diameter or 25mm X 25mm (1" X 1") square.	1 pc	1051-03
Foil Imprinting	Gold Heat Imprinting Foil		38mm (1-1/2") width gold foil, 60 meter roll	1 roll	3970-15
	Silver Heat Imprinting Foil		38mm (1-1/2") width silver foil, 60 meter roll	1 roll	3970-16
	Copper Heat Imprinting Foil		38mm (1-1/2") width copper foil, 60 meter roll	1 roll	3970-17
Safety Gear	Heat & Cut Resistant Gloves		Cut resistant & light heat resistant gloves. Durable & comfortable. One-size, machine washable	1 set	3982-00





craftplus
NUMBER: 3972-00
SERIAL NO. 180081
RPM: 0-8000
400W
CAUTION
SAFETY GLASSES & MASK REQUIRED
READ INSTRUCTIONS BEFORE USING
TO AVOID SERIOUS INJURY.
DISTRIBUTED BY
IVAN LEATHERCRAFT CO., LTD.
WWW.IVAN.TW
MADE IN CHINA

SPEED CONTROL
LOW
HIGH
OFF

craftplus

**BURNISHING HAND TOOL ACC
OPERATOR'S MAN
拋光機工具配件組**

**THANK YOU FOR BUYING THE CRAFTPLUS
拋光機**
Dear Burnishing Hand Tool Operator, Thank you for purchasing the
of operation, and please use properly to avoid any
of the tool. If you have any questions, please contact
CRAFTPLUS LEATHERCRAFT CO., LTD.
INDONESIA: 081 234 1234 5678

BENCH BURNISHER

3972-00

- Dedicated machine for sanding, slicking leather and honing leather tools
- Highly portable and lightweight
- Electric powered, fast results
- US, UK, EU & AU model available

 VIDEO AVAILABLE



PRODUCT SPECIFICATIONS	
Item No.	3972-00
Power Consumption	110V AC 60HZ (US) 230V AC 50HZ (AU) 220/240V AC 50HZ (UK/EU)
Dimensions	31 X 16 X 14.5 cm (12.2" X 6.3" X 5.6")
Weight	2.7 KG (6 LBS)
Packaging	41 X 29 X 20 cm (16.1" X 11.4" X 7.9")
Gross Weight	5 KG (11 LBS)



Slicking



Sharpening & Honing



Sanding

Features & Capabilities



Maximum Performance. Smallest Package

Adjustable speed from 0~8,000 RPM. Everything you need in a small portable design.

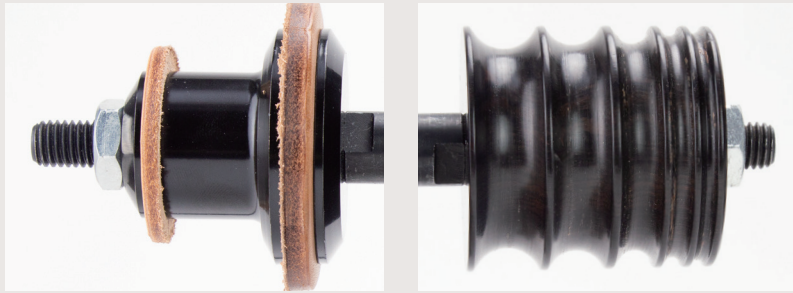

Multitask. Accomplish More

2 accessory spindles set up independently, giving you freedom to do more.



Capable & Speed

Powerful features for the things you do everyday, tasks like grinding, polishing, and even honing tools. It helps you do better. Faster.









Ready. Right Out Of The Box

Preinstalled components, exactly what you need right out of the box. Giving you superior user experience.





BENCH BURNISHER ACCESSORIES

Sharpening & Honing	Small Leather Disc		Vegetable-tanned leather discs, available in 40mm (1-37/64") & 59mm (2-3/8") diameters, strop hand tools from knives to edge bevelers. Use with polishing compound for best result	1 pc	3972-10
	Large Leather Disc			1 pc	3972-11
Sanding	120 Grits Sanding Sleeve		120 & 80 grits sanding sleeve. Shave & shape your edge. Fits over sanding drum	1 pc	3972-12
	80 Grits Sanding Sleeve			1 pc	3972-13
Slicking	Sandalwood Slicker		50mm (2") diameter wooden slicker, burnish edges to a slick finish. Features 5 grooves for different leather thicknesses	1 pc	3972-14
Tool Pack	Burnishing Hand Tool Accessory Pack		Hand tool set for Bench Burnisher. Designed for honing, polishing, sanding and slicking small areas and fine processes. 16 parts included	1 set	3972-50
Safety Gear	Safety Glasses		Lightweight safety glasses offers superior protection, comfort and fit. 100% polycarbonate scratch-resistant lenses	3 pcs	3982-03



Sharpening & Honing



Buffing





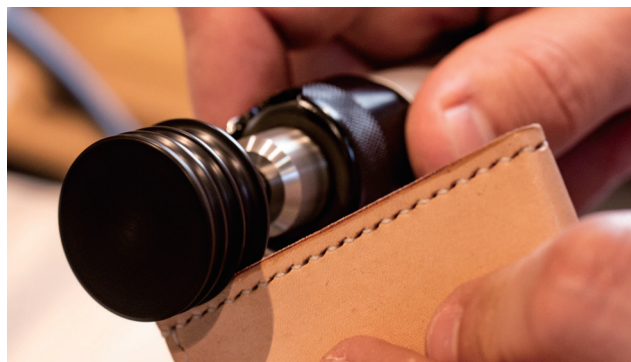

Sanding

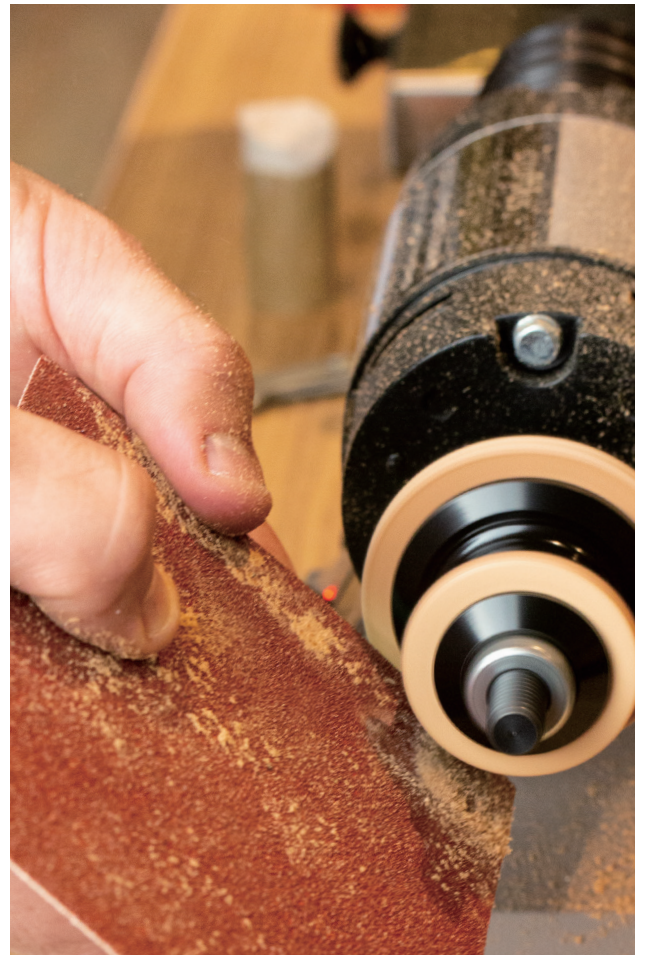

Slicking



POLISHING COMPOUNDS

			Item No.	Qty
White Polishing Compound		Used for light polishing. Primarily used in the final finish of steel, stainless steel and zinc	3324-01	1 pc
Red Polishing Compound		Used for regular cleaning of metals. Most commonly used for steel blades and precious metals	3324-02	1 pc
Green Polishing Compound		Used for high gloss polishing. Primarily used in the final buffing stage for stainless steel, brass, Aluminum, nickel and chrome. Considered the best polishing compound for most metals	3324-03	1 pc
Brown Polishing Compound		Used for regular cleaning of hard metals. Good for removing light scratches, imperfections and oxidation	3324-04	1 pc
Grey Polishing Compound		Used for heavy duty cleaning of hard metals	3324-05	1 pc









TIPPING MACHINE

3973-00

- Designated machine for belt making. The machine comes with tipping die (1), buckle die (1), 3mm tube (4) and 4mm tube (4)
- Quiet, non-electric, hand operated machine
- Integrates multiple processes into one
- Cuts belt tips, buckle holes and hardware holes in one stroke
- Works for straps between 19-50mm (3/4" -2") wide and up to 5mm (3/16") thick

PRODUCT SPECIFICATIONS

Item No.	3973-00
Dimensions	31 X 42 X 74 cm (12" X 16.5" X 29")
Weight	25 KG (55 LBS)
Packaging	38 X 28 X 42cm (15" X 11" X 16.5")
Gross Weight	26 KG (57 LBS)

Features & Capabilities

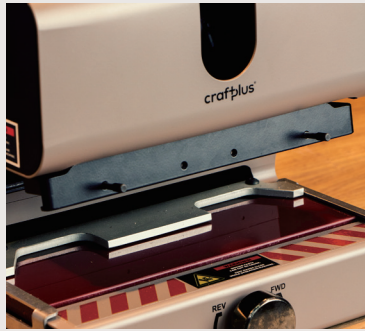

Power In Disguise

A powerful cam actuated drive, puts out 4 tons of force. Remarkable for a machine this size.

Efficiency. Simplified

Patented measurement and fence system, cuts symmetrical, perfectly tipped belt straps.



Industry Standard For The Masses

Industrial grade, high quality PP abrasion resistant boards, maximize tool life and maintain production speed. Performance you can trust at home.

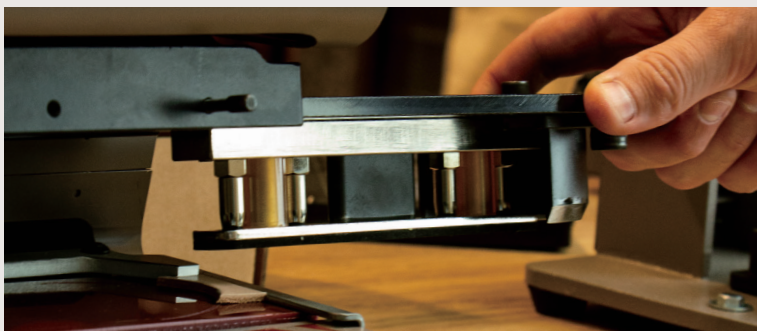

Long Life, High Precision

High-carbon alloy steel cutting die and punch tubes, delivers toughness and superior wear resistance (die comes with 5mm tubes).

More Combination More Possibilities

Switch tube sizes at will, giving you more customized styles and hardware options.

MORE DETAILS



2018 A' Design Award & Competition, Bronze Winner of Prosumer Products, Tools & Machinery Design Category.







2018 Golden Pin Design Award

Taiwan Patent Number D191230
China Patent Number ZL 2017 3 0586584.X

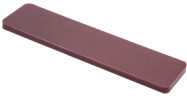



TIPPING MACHINE ACCESSORIES

Cutting	Cutting Board		69 X 253 X 10 mm (2-3/4" X 10" X 3/8") PP cutting board, maximizes tool life and maintain production speed	1 pc	3973-15
	Tipping Die		58.5 X 41.5 mm (2-5/16" X 1-5/8") high-carbon alloy steel replacement tipping die. For use with tipping machine cutting die	1 pc	3973-14
Hole Punch	3mm (1/8") Punch Tube			1 pc	3973-10
	4mm (5/32") Punch Tube		High-carbon alloy steel replacement tubes. For use with Tipping Machine cutting die	1 pc	3973-11
	5mm (13/64") Punch Tube			1 pc	3973-12
	Oval Tube		34.8 X 4.3mm (1-3/8" X 11/64") High-carbon alloy steel tube. Compatible with most buckles	1 pc	3973-13
Safety Gear	Safety Glasses		Lightweight safety glasses offers superior protection, comfort and fit. 100% polycarbonate scratch-resistant lenses	3 pcs	3982-03





CLICKER PRESS

3974-00

- Quiet, non-electric, hand powered clicker press
- Dedicated machine for cutting small sheets of leather; comes with cutting boards (2) and 79.4mm (3-1/8") diameter circle die (1)
- 4 tons of force delivers precise cuts with ease
- This product only works with 19mm (3/4") and 34mm (1-11/32") height cutting dies



MORE DETAILS

Taiwan Patent Number D192792
China Patent Number ZL 2018 3 0071474.4

 VIDEO AVAILABLE



PRODUCT SPECIFICATIONS

Item No.	3974-00
Dimensions	32.5 X 20 X 72 cm (12.8" X 7.9" X 27.7")
Weight	28 KG (62 LBS)
Packaging	44 X 31 X 39 cm (17.3" X 12.2" X 15.4")
Gross Weight	30 KG (66 LBS)

Features & Capabilities



Scrap. No More

Get more out of your scrap, cuts shapes and lace easily and quickly. No need for outlet, it's your perfect scrap cutting partner.



More Than Meets The Eye

Dual cam actuated drive with four stabilizers, keeps pressure even, deliver same results every time.



Room To Do More

270 X 190mm (10.6" X 7.4") cutting surface, fits up to 260 X 150mm (10.2" X 5.9") cutting die. Maximize your scrap leather just got easier.









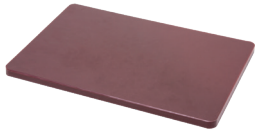

Remarkable Power In One Sleek Package

Aluminum casing and steel base construction that delivers 4 tons of force in one incredibly sleek design.



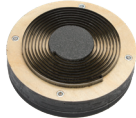
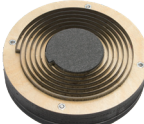

CLICKER PRESS ACCESSORIES

Cutting	Small Cutting Board		190 X 270 X 10mm (7-15/32" X 10-5/8" X 3/8") PP cutting board	1 pc	3974-10
	Large Cutting Board		190 X 270 X 23mm (7-15/32" X 10-5/8" X 7/8") PP cutting board	1 pc	3974-11
	Round Cutting Die		79mm (3-7/64") diameter X 19mm (3/4")	1 pc	3974-15
	Square Cutting Die		90 X 90 X 19mm (3-9/16" X 3-9/16" X 3/4")	1 pc	3974-16
	Keychain Cutting Die		128 X 41 X 91mm (5" X 1-5/8" X 3/4")	1 pc	3974-17
	Scalloped Cutting Die		44mm (1-3/4") diameter X 19mm (3/4")	1 pc	3974-18
	Small Spiral Cutting Die		Cuts 3mm (1/8") width lace, approx. 183cm (72") in length; Die size: 126 X 34mm (5" X 1-11/32")	1 pc	3974-25
	Medium Spiral Cutting Die		Cuts 4.5mm (3/16") width lace, approx. 152cm (60") in length; Die size: 142 X 34mm (5-5/8" X 1-11/32")	1 pc	3974-26
	Large Spiral Cutting Die		Cuts 6.5mm (1/4") width lace, approx. 122cm (48") in length; Die size: 146 X 34mm (5-3/4" X 1-11/32")	1 pc	3974-27
Safety Gear	Safety Glasses		Lightweight safety glasses offers superior protection, comfort and fit. 100% polycarbonate scratch-resistant lenses.	3 pcs	3982-03







craftplus
ITEM NUMBER 3971-00

MODEL:	POTARY STRAP CUTTER	SERIAL NO.:	39076
POWER:	110V AC 40HZ 40W	HEIGHT:	185C
CAPACITY:	8PM		
MAXIMUM MATERIAL THICKNESS:	1000		

GENERAL RECOMMENDATIONS
BEST USED FOR SOFT PLIABLE LEATHERS & TEXTILE FABRICS

CAUTION

 ROTATING BLADE (HAZARD!)
KEEP HANDS CLEAR!
DISCONNECT POWER
BEFORE CHANGING BLADES.

 READ INSTRUCTIONS BEFORE USING
TO AVOID SERIOUS INJURY.



DISTRIBUTED BY
WAN LEATHERCRAFT CO. LTD.
WWW.VIVALTI.IT

MADE IN CHINA

FWD
REV



ROTARY STRAP CUTTER

3971-00

- Electric strap and belt blank cutter, perfect for smaller cutting projects
- Portable and compact, can also mount to a workbench
- Blades and spacers remove easily for quick change and easy maintenance
- Features maximum cutting width of 127mm (5") and 4.5mm (1/16 oz) thick
- Comes with 12 extra spacers and 4 preinstalled blades.
- US, UK, EU & AU models available

PRODUCT SPECIFICATIONS

Item No.	3971-00
Power Consumption	110V AC 60HZ (US) 230V AC 50HZ (AU) 220/240V AC 50HZ (UK/EU)
Dimensions	37 X 16.5 X 34.5 cm (14.6" X 6.5" X 13.6")
Weight	15.4 KG (34 LBS)
Packaging	49 X 31 X 43 cm (19.3" X 12.2" X 17")
Gross Weight	20 KG (44LBS)

Features & Capabilities

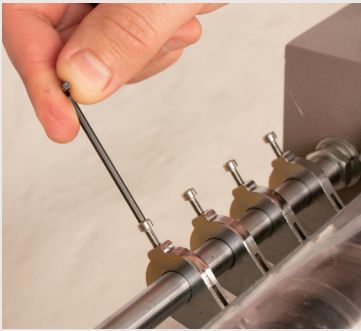

Freedom to customize strap width

Has the ability to cut 3mm (1/8") laces to 127mm (5") belt blanks with the use of 3mm and 6mm spacers.

Quality you expect

Highspeed stainless steel blades, give your belts and straps uniform and professional appearance.





The power to cut more

An economical alternative to cutting by hand, giving you the ability to produce more straps and belt blanks in the same amount of time.



ROTARY STRAP CUTTER ACCESSORIES

	Highspeed Stainless Steel Blade		45mm (1-3/4") diameter highspeed stainless steel replacement blade	2 pcs	3971-10
Cutting	Strap Cutter Roller		45mm (1-3/4") diameter X 136mm (5-11/32") replacement nylon roller	1 pc	3971-12
	Ejector		Replacement ejector for Rotary Strap Cutter	2 pcs	3971-11





EDGE DYEING MACHINE

3976-00

- 49mm (2") barrel-shaped roller with adjustable speed
- Suitable for various size projects
- Removeable paint tray for easy cleaning
- Compact design takes up less space
- US, UK, EU & AU models available

PRODUCT SPECIFICATIONS	
Item No.	3976-00
Power Consumption	110V AC 60HZ (US) 230V AC 50HZ (AU) 220/240V AC 50HZ (UK/EU)
Dimensions	17 X 25 X 7.8 cm (6.75" X 9.88" X 3.2")
Weight	1.4 KG (3 LBS)
Packaging	13 X 23.5 X 34 cm (5" X 9.25" X 13.5")
Gross Weight	1.5 KG (3.3LBS)



 VIDEO AVAILABLE



Features & Capabilities



A step up for small production

Semi-automatic machine allowing an accurate and quick application, especially on large surfaces.



Get more out of your edge paint

Suitable to paint the edges of handbags, wallets, watch straps, belts and other leather accessories.



Works well with others

Compatible with major edge paint brands like Eco-Flo, Giardini, Stahl and more.

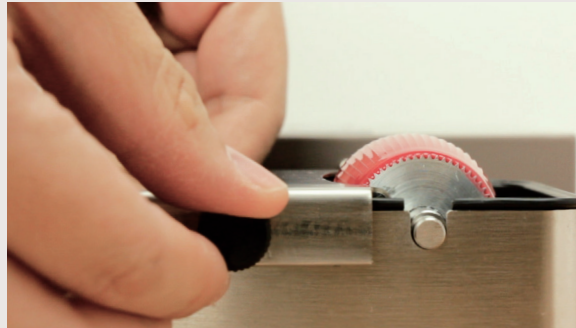

Most intuitive operation

The amount of paint to be applied can be adjusted by the cover to obtain a uniform edge.





EDGE PAINTS

Sample (Shown on Veg-tanned Leather)	Color	Swatch	Product Spec	Item No.
	Black		250ml (8.5 fl. oz.)	2810-01
	Dark Brown		250ml (8.5 fl. oz.)	2810-03
	Light Brown		250ml (8.5 fl. oz.)	2810-04
	White		250ml (8.5 fl. oz.)	2810-06
	Dark Bordeaux		250ml (8.5 fl. oz.)	2810-07
	Red		250ml (8.5 fl. oz.)	2810-08
	Yellow		250ml (8.5 fl. oz.)	2810-09
	Green		250ml (8.5 fl. oz.)	2810-10
	Navy Blue		250ml (8.5 fl. oz.)	2810-11
	Aluminum		250ml (8.5 fl. oz.)	2810-12
	Pink		250ml (8.5 fl. oz.)	2810-13
	Orange		250ml (8.5 fl. oz.)	2810-14
	Turquoise		250ml (8.5 fl. oz.)	2810-15
	Neutral		250ml (8.5 fl. oz.)	2810-20
	Gloss Top Coat		250ml (8.5 fl. oz.)	2810-30





1.25 TON

Down

craftplus

TUBULAR RIVET SETTING DIES
FOR MULTI-PURPOSE LEATHER HAND PRESS
【空心釘、中空釘模具組】
多功能皮革手壓機專用
2PCS

SOLID BRASS GROMMET SETTING DIES
FOR MULTI-PURPOSE LEATHER HAND PRESS
【純銅雞眼模具組】
多功能皮革手壓機專用
2PCS

SNAP SETTING DIES
FOR MULTI-PURPOSE LEATHER HAND PRESS
【彈簧扣、棉釘模具組】
多功能皮革手壓機專用
2PCS



MULTI-PURPOSE LEATHER HAND PRESS

3960-00

- Quiet, non-electric, hand powered leather press
- Dedicated machine for imprinting and embossing vegetable tanned leather
- Designed to set grommets, eyelets, rivets, snaps and spots
- Punch round, diamond holes and lacing holes
- Highly portable and lightweight
- Works with variety of add-ons (adaptors sold separately)

PRODUCT SPECIFICATIONS

Item No.	3960-00
Dimensions	31 X 15 X 62 cm (12.2" X 5.8" X 24.5")
Weight	8 KG (18 LBS)
Packaging	54 X 37 X 12 cm (21.25" X 14.6" X 4.75")
Gross Weight	9.5 KG (21 LBS)



Round Spots

Rivets & Snaps

Stamps

Punch Tubes

Stitching Chisels

Features & Capabilities



Small & Mighty

Lightweight and powerful. Up to 1.25 tons of output power. Surpassing any other hand press in its class.



Micro Adjustment At Your Fingertips

Most intuitive operation, handles leather and adapters smoothly and effortlessly.



Simple Set Up, Ready To Use In Minutes

Fasten machine on work bench or stand, attach handle and it's ready to use.



Do More With Add-Ons

20+ custom dies & adapters optimize productivity (adapters sold separately).

MORE DETAILS



A'DESIGN AWARD
WINNER 2017
SILVER

A' Design Award And Competition, 2017 Silver Winner of Prosumer Products, Tools and Machinery Design Category.

Taiwan Patent Number D177114
U.S.A Patent Number D771,725S
China Patent Number ZL 2015 3 0400535.3







VIDEO
AVAILABLE



LEATHER HAND PRESS ACCESSORIES

Hardware Setters	Rivet Setting Dies		Multi-size dies for 7mm (9/32"), 9mm (3/8"), 10mm (25/64"), 13mm (1/2") rivets	8 pcs	3997-90
	Round Spot Setting Dies		For 6mm (1/4") I330-31/-41/-51/-61 round spots	2 pcs	3988-01
			For 9.5mm (3/8") I330-31/-41/-51/-61 round spots	2 pcs	3988-02
			For 11mm (7/16") I330-33/-43/-53/-63 round spots	2 pcs	3988-03
			For 12mm (1/2") I330-34/-44/-54/-64 round spots	2 pcs	3988-04
			For 3mm (1/8") I330-50 round spots	2 pcs	3988-05
	Snap Setting Dies		For 10mm (3/8") I249 series gloves snaps	4 pcs	3985-00
			For 10mm (3/8") I250 series line 16 snaps	4 pcs	3994-00
			For 13mm (1/2") I261 series line 20 snaps	4 pcs	3995-00
			For 15mm (5/8") I263 series line 24 snaps	4 pcs	3996-00
			Brass Grommet Setting Dies		For 5mm (3/16") I6722-01/I6723-01 solid brass grommets
	For 7.5mm (9/32") I6722-02/I6723-02solid brass grommets	2 pcs			39011-02
	For 8.5mm (5/16") I6722-03/I6723-03 solid brass grommets	2 pcs			39011-03
	For 10mm (3/8") I6722-04/I6723-04 solid brass grommets	2 pcs			39011-04
	For 12.5mm (1/2") I6722-05/I6723-05 solid brass grommets	2 pcs			39011-05
For 13.5mm (17/32") I6722-06/I6723-06 solid brass grommets	2 pcs	39011-06			









LEATHER HAND PRESS ACCESSORIES

Hardware Setters	Tubular Rivet Setting Die		For 1294 series tubular rivets	2 pcs	3998-00
	Eyelet Setting Dies		For 4mm (3/16") 1286-01/-02 eyelets	2 pcs	3992-00
			For 6mm (1/4") 1287-01/-02 eyelets	2 pcs	3992-01
			For 8mm (5/16") 1288-01/-02 eyelets	2 pcs	3992-02
	Rivets & Burrs Setting Dies		For #9 Rivets & Burrs	3 pcs	3983-01
			For #12 Rivets & Burrs	3 pcs	3983-02
For #14 Rivet & Burrs			3 pcs	3984-00	
Hole Punch	Punch Tube Adapter Set		For use with 3798 series rotary punch replacement tubes and 3003 series round & shape punch sets	2 pcs	3993-00
			For use with 3004-00 / 3004-04 punch sets	2 pcs	3993-11
			For use with 3004-10 / 3004-20 punch sets	2 pcs	3993-12
	Stitching Chisel Adapter Set		For use with 3009-00 Diamond Hole Chisel Set and 3008-00 Thonging Chisel Set	2 pcs	3993-00

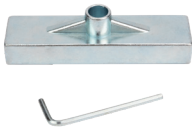
All hardware, punch tube, chisels and stamps are sold separately. Images are for demonstration purposes only.



LEATHER HAND PRESS ACCESSORIES

Stamp	Stamp Adapters	<p>A. </p> <p>B. </p> <p>C. </p>	<p>A. For 3mm (1/8"), 6.5mm (1/4") & 9.5mm (3/8") stamps</p> <p>B. For 2D/3D, 13m (1/2"), 19mm (3/4") & 26mm (1") alphabet, number & pattern stamps (except 8130-02/8131-02)</p> <p>C. Heavy duty ramfoot for 2D/3D, 13m (1/2"), 19mm (3/4") & 26mm (1") alphabet, number & pattern stamps (except 8130-02/8131-02), Spreads pressure evenly for a crisper impression</p>	3 pcs	3961-01
	Type Holder		Leather Hand Press Stamping Type Holder, for use with 4.5mm (3/16") and 6mm (1/4") Brass Imprinting set, allen wrench included.	2 pcs	3961-02
	3/16" Brass Imprint Set		Includes letters (67), numbers (30), symbols (28) & spacers (17).	1 set	3970-10
	1/4" Brass Imprint Set			1 set	3970-11
	Multi Use Custom Stamp		<p>Solid brass embossing plate with stamp adapter. Stamp adapter allows the plate to be used on 3960-00 Multi-Purpose Leather Hand Press. Artwork required for your custom order. Maximum logo design: 38mm (1-1/2") diameter or 25mm X 25mm (1" X 1") square.</p>	1 pc	1051-03
Storage	Storage Case		<p>1254 X 152 X 254 mm (10" X 6" X 10")</p> <p>Five-tier storage case, features 76 mm (3") deep top storage for large items and comes with four 229 X 114 X 32 mm (9" X 4-1/2" X 1-1/4") clear removable boxes. Each box has 18 slots with removable partitions.</p>	1 pc	8126-00
	2D/3D Stamp Rack		<p>297 X 160 X 60mm (11-11/16" X 6-5/16" X 2-3/8")</p> <p>storage rack, fits 2D, 3D stamps, 13mm (1/2"), 19mm (3/4"), 26mm (1") alphabet, number and pattern stamps. Stores up to 36 stamps and 4 stamp handles.</p>	1 pc	8125-00
	Mini 2D/3D Stamp Rack		<p>345 X 160 X 60mm (13-5/8" X 6-5/16" X 2-3/8")</p> <p>mini storage, fits mini 2D, 3D stamps, 3mm (1/2"), 19mm (3/4") alphabet, number and pattern stamps. Stores up to 46 stamps and 4 stamp handles.</p>	1 pc	8125-01

All hardware, punch tube, chisels and stamps are sold separately. Images are for demonstration purposes only.



Double Cap Rivet



Round Spot



Line 20 Snap



Glove Snap



Tubular Rivet



Brass Grommet

HARDWARE

		Cap	Post	Qty	SS
 <p>Stainless Steel Snaps</p>	SS	13mm (1/2")	5mm (3/16")	100 sets	1261-10
				1000 sets	1261-99
	15mm (5/8")	8mm (5/16")	100 sets	1263-10	
			1000 sets	1263-99	

		Cap	Post	Qty	SB	CP	AL
 <p>#9 Rivets & Burrs</p>	SB CP	12mm (1/2")	13mm (1/2")	50 sets	11280-20	11280-90	
			19mm (3/4")	50 sets	11281-20	11281-90	
			25mm (1")	50 sets	11282-20	11282-90	
 <p>#12 Rivets & Burrs</p>	SB CP	9.5mm (3/8")	13mm (1/2")	75 sets	11280-21	11280-91	
			19mm (3/4")	75 sets	11281-21	11281-91	
			25mm (1")	75 sets	11282-21	11282-91	
 <p>#14 Rivets & Burrs</p>	SB CP AL	9.5mm (3/8")	7mm (1/4")	50 sets	11277-21	11277-01	11277-31
				1000 sets	11277-211	11277-011	11277-311
			9mm (3/8")	50 sets	11278-21	11278-01	11278-31
				1000 sets	11278-211	11278-011	11278-311
			13mm (1/2")	50 sets	11279-21	11279-01	11279-31
				1000 sets	11279-211	11279-011	11279-311

Sizing

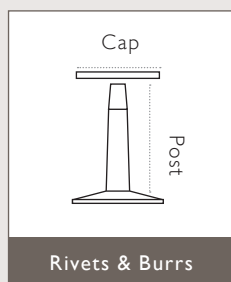
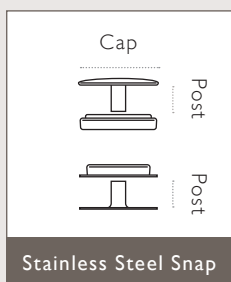

Material

Symbol	Code	Material
SB	SB	Solid Brass
SS	SS	Stainless Steel
CP	CP	Copper
AL	AL	Aluminum

HARDWARE

		Cap	Post	Qty	BP	NP	AB	AN	BN	AC
 <p>Brass Double Cap Rivets</p>	<p>SB</p>	7mm (9/32")	7mm (9/32")	100 sets	1379-11	1379-12				
				1000 sets	1379-21	1379-22				
		9mm (13/32")	9mm (3/8")	100 sets	1381-11	1381-12				
				1000 sets	1381-21	1381-22				
		9mm (13/32")	12mm (1/2")	100 sets	1383-11	1383-12				
				1000 sets	1383-21	1383-22				
 <p>Double Cap Rivets</p>	7mm (9/32")	7mm (9/32")	100 sets	1371-11	1371-12	1371-15	1371-16			
			1000 sets	1371-21	1371-22	1371-25	1371-26			
	9mm (3/8")	9mm (3/8")	100 sets	1373-11	1373-12	1373-15	1373-16			
			1000 sets	1373-21	1373-22	1373-25	1373-26			
	9mm (3/8")	12mm (1/2")	100 sets	1375-11	1375-12	1375-15	1375-16			
			1000 sets	1375-21	1375-22	1375-25	1375-26			
	9mm (3/8")	15mm (5/8")	100 sets	1377-11	1377-12	1377-15	1377-16			
			1000 sets	1377-21	1377-22	1377-25	1377-26			
	13mm (1/2")	7mm (9/32")	100 sets	1371-81	1371-82	1371-83	1371-84	1371-85	1371-86	
			1000 sets	1371-811	1371-821	1371-831	1371-841	1371-851	1371-861	
13mm (1/2")	10mm (3/8")	100 sets	1373-81	1373-82	1373-83	1373-84	1373-85	1373-86		
		1000 sets	1373-811	1373-821	1373-831	1373-841	1373-851	1373-861		
13mm (1/2")	12mm (1/2")	100 sets	1375-81	1375-82	1375-83	1375-84	1375-85	1375-86		
		1000 sets	1375-811	1375-821	1375-831	1375-841	1375-851	1375-861		
 <p>Flower Double Cap Rivets</p>	7mm (9/32")	7mm (9/32")	100 sets	1360-11	1360-12					
			1000 sets	1360-21	1360-22					
	9mm (3/8")	9mm (3/8")	100 sets	1361-11	1361-12					
			1000 sets	1361-21	1361-22					
	9mm (3/8")	12mm (1/2")	100 sets	1362-11	1362-12					
			1000 sets	1362-21	1362-22					

Finishes A line of nickel free plated hardware finishes

Finish	Brass Plate	Nickel Plate	Antique Brass	Antique Nickel	Black Nickel	Antique Copper	Copper	Black	Brown
Swatch									
Code	BP	NP	AB	AN	BN	AC	CP	BL	BR

HARDWARE

	Cap	Post	Qty	BP	NP	AB	AN	BN	AC
 Star Double Cap Rivets	7mm (9/32")	7mm (9/32")	100 sets	<i>1363-11</i>	<i>1363-12</i>				
			1000 sets	<i>1363-21</i>	<i>1363-22</i>				
	9mm (3/8")	9mm (3/8")	100 sets	<i>1364-11</i>	<i>1364-12</i>				
			1000 sets	<i>1364-21</i>	<i>1364-22</i>				
	9mm (3/8")	12mm (1/2")	100 sets	<i>1365-11</i>	<i>1365-12</i>				
			1000 sets	<i>1365-21</i>	<i>1365-22</i>				
 Single Cap Rivets	7mm (9/32")	7mm (9/32")	100 sets	<i>1271-11</i>	<i>1271-12</i>	<i>1271-15</i>	<i>1271-16</i>		
			1000 sets	<i>1271-21</i>	<i>1271-22</i>	<i>1271-25</i>	<i>1271-26</i>		
	9mm (3/8")	9mm (3/8")	100 sets	<i>1273-11</i>	<i>1273-12</i>	<i>1273-15</i>	<i>1273-16</i>		
			1000 sets	<i>1273-21</i>	<i>1273-22</i>	<i>1273-25</i>	<i>1273-26</i>		
	9mm (3/8")	12mm (1/2")	100 sets	<i>1275-11</i>	<i>1275-12</i>	<i>1275-15</i>	<i>1275-16</i>		
			1000 sets	<i>1275-21</i>	<i>1275-22</i>	<i>1275-25</i>	<i>1275-26</i>		
 Texture Single Cap Rivets	7mm (9/32")	7mm (9/32")	100 sets	<i>1271-311</i>	<i>1271-321</i>	<i>1271-361</i>	<i>1271-351</i>		
			1000 sets	<i>1271-312</i>	<i>1271-322</i>	<i>1271-362</i>	<i>1271-352</i>		
	9mm (3/8")	9mm (3/8")	100 sets	<i>1273-311</i>	<i>1273-321</i>	<i>1273-361</i>	<i>1273-351</i>		
			1000 sets	<i>1273-312</i>	<i>1273-322</i>	<i>1273-362</i>	<i>1273-352</i>		
	9mm (3/8")	12mm (1/2")	100 sets	<i>1275-311</i>	<i>1275-321</i>	<i>1275-361</i>	<i>1275-351</i>		
			1000 sets	<i>1275-312</i>	<i>1275-322</i>	<i>1275-362</i>	<i>1275-352</i>		
 Round Spot	3mm (1/8")		100 pcs		<i>1330-501</i>				
			1000 pcs		<i>1330-50</i>				
	6mm (1/4")		100 pcs	<i>1330-01</i>	<i>1330-02</i>	<i>1330-03</i>	<i>1330-04</i>		
			1000 pcs	<i>1330-81</i>	<i>1330-91</i>	<i>1330-85</i>	<i>1330-95</i>		
	9.5mm (3/8")	6.5mm (1/4")	100 pcs	<i>1330-05</i>	<i>1330-06</i>	<i>1330-07</i>	<i>1330-08</i>		
			1000 pcs	<i>1330-82</i>	<i>1330-92</i>	<i>1330-86</i>	<i>1330-96</i>		
	11mm (7/16")		100 pcs	<i>1330-09</i>	<i>1330-10</i>	<i>1330-11</i>	<i>1330-12</i>		
			1000 pcs	<i>1330-83</i>	<i>1330-93</i>	<i>1330-87</i>	<i>1330-97</i>		
	12mm (1/2")		100 pcs	<i>1330-13</i>	<i>1330-14</i>	<i>1330-15</i>	<i>1330-16</i>		
			1000 pcs	<i>1330-84</i>	<i>1330-94</i>	<i>1330-88</i>	<i>1330-98</i>		

Sizing

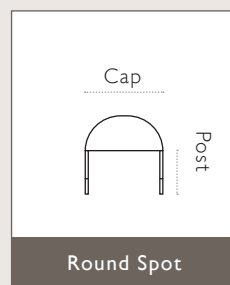
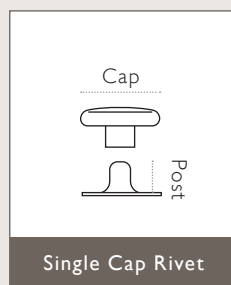
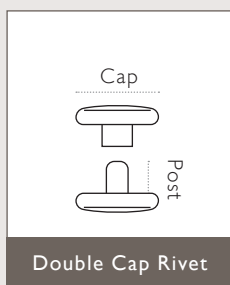



Material

Symbol	Material
SB	Solid Brass
SS	Stainless Steel
CP	Copper
AL	Aluminum

HARDWARE

	Cap	Qty	BP	NP	BL	BR	
 Glove Snaps	10mm (3/8")	100 sets	1249-13	1249-14	1249-11	1249-12	
		1000 sets	1249-33	1249-34	1249-31	1249-32	
 Line 16 Snaps	10mm (3/8")	100 sets	1250-13	1250-14	1250-11	1250-12	
		1000 sets	1250-33	1250-34	1250-31	1250-32	

	Cap	Post	Qty	BP	NP	BN	AC	AN	
 Line 20 & Line 24 Snaps	13mm (1/2")	5mm (3/16")	100 sets	1261-11	1261-12	1261-13	1261-16	1261-15	
			1000 sets	1261-21	1261-22	1261-23	1261-26	1261-25	
	15mm (5/8")	8mm (5/16")	100 sets	1263-11	1263-12	1263-13	1263-16	1263-15	
			1000 sets	1263-21	1263-22	1263-23	1263-26	1263-25	

	Cap	Post	Qty	BP	NP	CP	
 Semi Tubular Rivets	8mm (5/16")	8mm (5/16")	100 pcs	1294-52	1294-51	1294-53	
			1000 pcs	1294-522	1294-512	1294-532	
		11mm (7/16")	100 pcs	1294-72	1294-71	1294-73	
			1000 pcs	1294-722	1294-712	1294-732	
		14mm (9/16")	100 pcs	1294-92	1294-91	1294-93	
			1000 pcs	1294-922	1294-912	1294-932	
 Tubular Rivet	8mm (5/16")	8mm (5/16")	100 pcs		1294-15		
			1000 pcs		1294-25		
		11mm (7/16")	100 pcs		1294-17		
			1000 pcs		1294-27		

Sizing

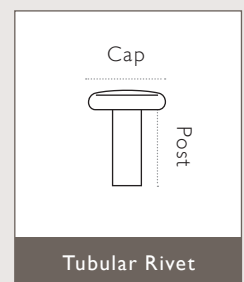
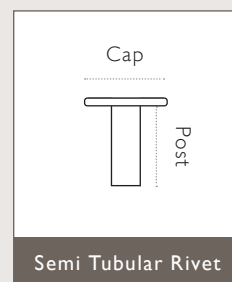
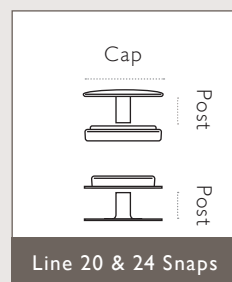
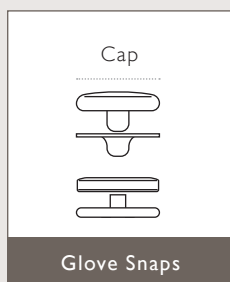

HARDWARE

		Cap	Hole	Post	Qty	BP	NP	BN	AB	AN
 <p>Brass Grommets</p>	SB	9mm (3/8")	5mm (3/16")	10mm (3/8")	100 sets	16723-11	16722-11			
					1000 sets	16723-21	16722-21			
		13mm (1/2")	6mm (1/4")	100 sets	16723-12	16722-12				
					1000 sets	16723-22	16722-22			
		15mm (5/8")	7.5mm (9/32")	12.5mm (1/2")	100 sets	16723-13	16722-13			
					1000 sets	16723-23	16722-23			
		17mm (5/8")	5.5mm (7/32")	7mm (9/32")	100 sets	16723-14	16722-14			
					1000 sets	16723-24	16722-24			
23mm (7/8")	8.5mm (5/16")	13.5mm (17/32")	100 sets	16723-15	16722-15					
			1000 sets	16723-25	16722-25					
23mm (7/8")	6mm (1/4")	7mm (9/32")	100 sets	16723-16	16722-16					
			1000 sets	16723-26	16722-26					
 <p>Eyelets</p>		8mm (5/16")	4.2mm (5/32")	6mm (1/4")	100pcs	1286-11	1286-12	1286-13	1286-15	1286-16
					1000 sets	1286-21	1286-22	1286-23	1286-25	1286-26
		12mm (1/2")	6mm (1/4")		100pcs	1287-11	1287-12			
					1000 sets	1287-21	1287-22			
		15mm (5/8")	8.5mm (5/16")		100pcs	1288-11	1288-12			
					1000 sets	1288-21	1288-22			

Sizing

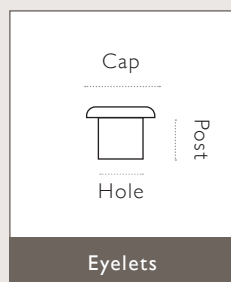
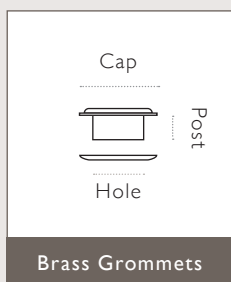

Material

Symbol	Material
SB	Solid Brass
SS	Stainless Steel
CP	Copper
AL	Aluminum





STITCHING CHISELS

Diamond Hole Chisel Piece Set		Gap Size			Item No.	Qty
		2mm (5/64")	3mm (1/8")	4mm (5/32")		
	1 prong				3009-00	11 pcs
	2 Prongs	●	●	●		
	4 Prongs	●	●	●		
	6 Prongs	●	●	●		



Thonging Chisel Set		Hole Size			Item No.	Qty
		1.5mm (1/16")	2.5mm (3/32")	3mm (1/8")		
	1 prong	●	●	●	3008-00	7 pcs
	3 prongs	●	●	●		

PUNCHES

	Size							Qty
	1.5mm (1/16")	2mm (5/64")	2.3mm (3/32")	3.1mm (1/8")	3.5mm (9/64")	4mm (5/32")	4.8mm (3/16")	
<p>Punch Tubes</p>	3798-00	3798-10	3798-11	3798-12	3798-13	3798-14	3798-15	1 pc

	Size											Item No.	Qty
	2mm (5/64")	2.3mm (3/32")	3.1mm (1/8")	3.5mm (9/64")	4mm (5/32")	4.8mm (3/16")	5.5mm (7/32")	6.3mm (1/4")	6.8mm (17/64")	7.1mm (9/32")	7.8mm (5/16")		
<p>Mini Round Punch Set</p>	●	●	●	●	●	●						3003-00	7 pcs
<p>Maxi Round Punch Set</p>						●	●	●	●	●	●	3004-00	7 pcs
<p>Oval Punch Set</p>	●	●	●	●	●	●						3004-20	7 pcs

PUNCHES

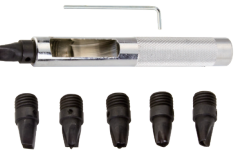
	Size	Shape						Item No.	Qty
		Moon	Diamond	Triangle	Heart	Flower	Star		
 <p>Mini Shape Punch Set</p>	4mm (5/32")	●	●	●	●	●	●	3003-04	7 pcs
 <p>Medium Shape Punch Set</p>	5mm (13/64")	●	●	●	●	●	●	3004-04	7 pcs
 <p>Maxi Shape Punch Set</p>	6mm (15/64")	●	●	●	●	●	●	3004-10	7 pcs

Punch Shapes

Style	Round	Oval	Moon	Diamond	Triangle	Heart	Flower	Star
Shape	●	●	☾	◆	▲	♥	✿	★

Round Punch Scale Chart

Size	2mm (5/64")	2.3mm (3/32")	3.1mm (1/8")	3.5mm (9/64")	4mm (5/32")	4.8mm (3/16")	6.3mm (1/4")	6.8mm (17/64")	7.1mm (9/32")	7.8mm (5/16")
I:I Scale	●	●	●	●	●	●	●	●	●	●







A complete personalization stamp solution, Craftplus® Multi-Purpose Leather Hand Press work together with these stamps to enhance your work and save time.

SIZING:



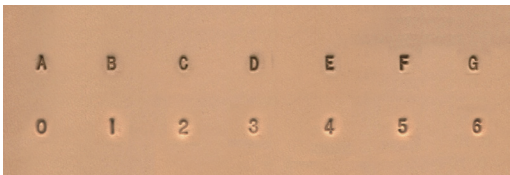
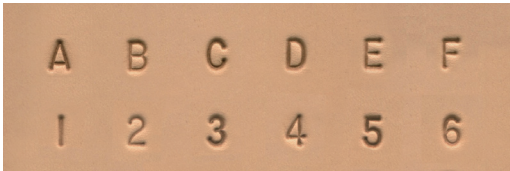
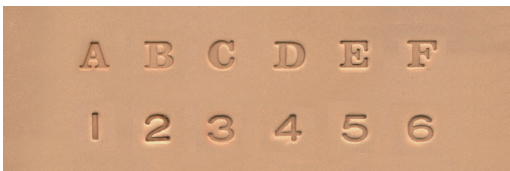
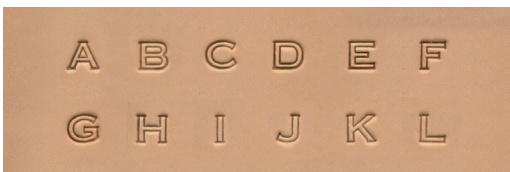

The sizing information refers to the approximate height of the stamps. The size may vary slightly depends on the style, design, typical tolerance and measuring instruments.

AVAILABILITY:

Most items are in inventory and ready to ship. Items mark with "*" are non-stock items, please contact us for quote.

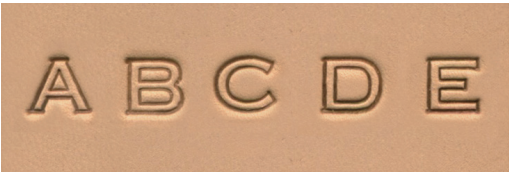

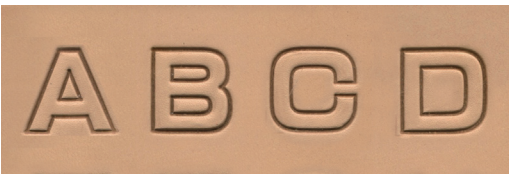
STAMP SETS		Item No.	Qty
	3mm (1/8") Simple Alphabet, Number & Symbols Stamp Set	8137-10	38 pcs
	6.5mm (1/4") Simple Alphabet & Number Stamp Set	8137-00	36 pcs
	6.5mm (1/4") Serif Alphabet Stamp Set	4903-00	26 pcs
	6.5mm (1/4") Serif Alphabet & Number Stamp Set	8134-00	36 pcs
	6.5mm (1/4") Block Alphabet Stamp Set	4909-00	26 pcs
	6.5mm (1/4") Old English Alphabet, Number & Symble Stamp Set	8142-20	38 pcs
	9.5mm (3/8") Fancy Alphabet Stamp Set	4907-00	26 pcs

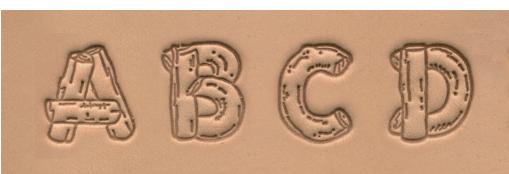
STAMP SETS

		Item No.	Qty
	13mm (1/2") Standard Uppercase Alphabet Stamp Set	8130-00	26 pcs
	13mm (1/2") Script Alphabet Stamp Set	8140-00	26 pcs
	13mm (1/2") Block Alphabet Stamp Set	8143-00	26 pcs
	19mm (3/4") Standard Uppercase Alphabet Stamp Set	8131-00	26 pcs
	19mm (3/4") Block Alphabet Stamp Set	8141-00	26 pcs
	19mm (3/4") Leather Art Stamp Set	8145-00	26 pcs
	19mm (3/4") Old English Alphabet & Symbol Stamp Set	8142-00	28 pcs
	19mm (3/4") Script Alphabet Stamp Set	8139-00	26 pcs
	19mm (3/4") Wood Grain Desing Stamp Set	8138-00	26 pcs

STAMP SETS		Item No.	Qty
	19mm (3/4") Runic/Celtic Alphabet Stamp Set	8146-00 *	26 pcs
	19mm (3/4") Hebrew Alphabet Stamp Set	8147-00 *	26 pcs
	19mm (3/4") Greek Alphabet Stamp Set	8148-00 *	26 pcs
	26mm (1") Standard Uppercase Alphabet Stamp Set	8132-00	26 pcs
	6.5mm (1/4") Serif Number Stamp Set	4904-00	10 pcs
	9.5mm (3/8") Fancy Number Stamp Set	4908-00	9 pcs
	13mm (1/2") Standard Number Stamp Set	8136-00	9 pcs
	19mm (3/4") Standard Number Stamp Set	8135-00	9 pcs
	19mm (3/4") Old English Number Stamp Set	8142-10	10 pcs

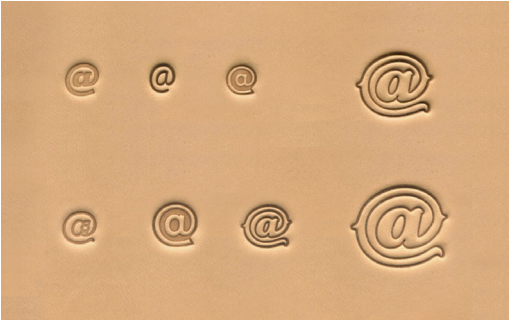
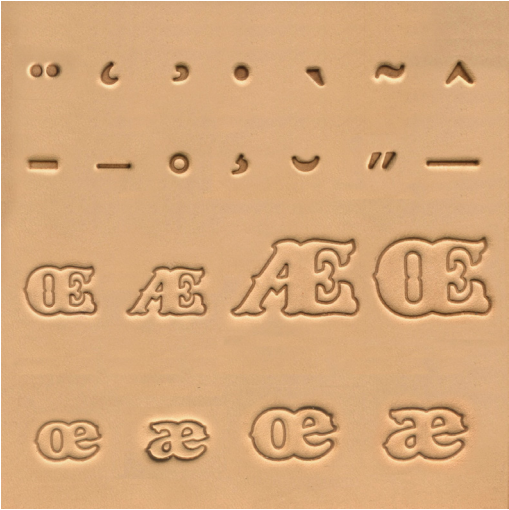
STAMP SETS

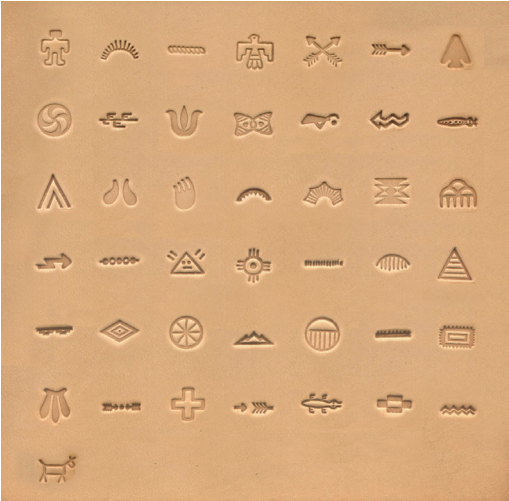
		Item No.	Qty
	3mm - 26mm (1/8" - 1")@ Stamp Set	8154-00	8 pcs
	9.5mm (3/8"), 13mm (1/2"), 19mm (3/4") Alphabet Accent Stamp Set	8155-00	22 pcs
	13mm (1/2") Norwegian Uppercase Alphabet Set	88572-00	3 pcs
	6.5mm (1/4") Native American Symbol Stamp Set	8160-00	43 pcs





STAMP SETS

		Item No.	Qty
	6.5mm (1/4") Sizing Stamp Set	8166-00	41 pcs
	6.5mm (1/4") Inspirational Word Stamp Set	8164-00	12 pcs
	13mm (1/2") Christmas Stamp Set	8165-00	12 pcs
	13mm (1/2") Cartoon Animal Stamp Set	88552-00	12 pcs

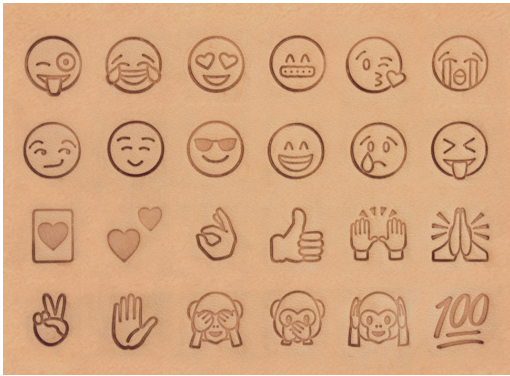

STAMP SETS

		Item No.	Qty
	13mm (1/2") 3D Animal Stamp Set (A)	88500-00	12 pcs
	13mm (1/2") 3D Animal Stamp Set (B)	88501-00	12 pcs
	13mm (1/2") Geometric Design Stamp Set	8163-00	12 pcs
	13mm (1/2") Floral Stamp Set	8162-00	12 pcs

STAMP SETS

		Item No.	Qty
	13mm (1/2") Emoji Stamp Set	8156-00	24 pcs
	13mm (1/2") Sports Stamp Set	8158-00	12 pcs
	16mm (5/8") Zodiac Stamp Set	8151-00	12 pcs
	26mm (1") Chinese Character Stamp Set	88551-00	6 pcs

STAMP SETS

		Item No.	Qty
	26mm (1") Chinese Character Stamp Set	8149-00	12 pcs
	26mm (1") Celtic Stamp Set	8161-00	12 pcs
	26mm (1") Zodiac Stamp Set	8150-00	12 pcs



SIZING:

The sizing information refers to the height and width of the stamp. The actual pattern size is smaller and may vary depends on the style, design, typical tolerance and measuring instruments.

AVAILABILITY:



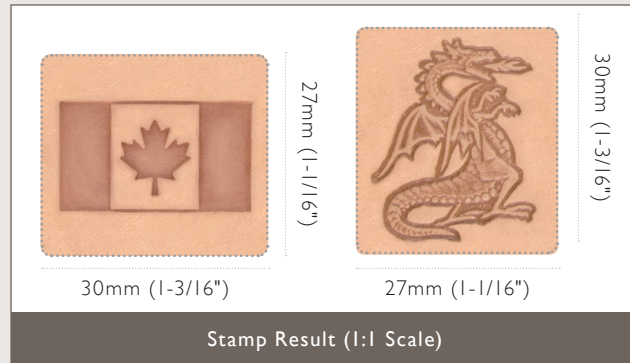
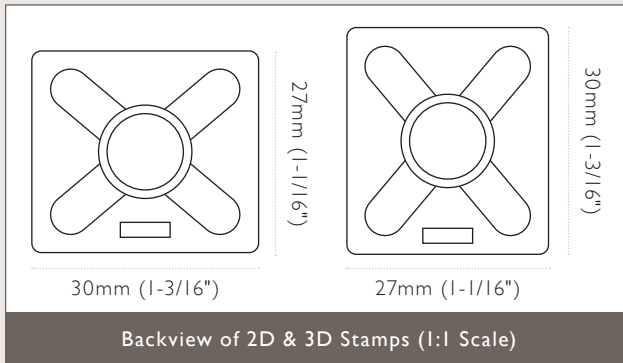



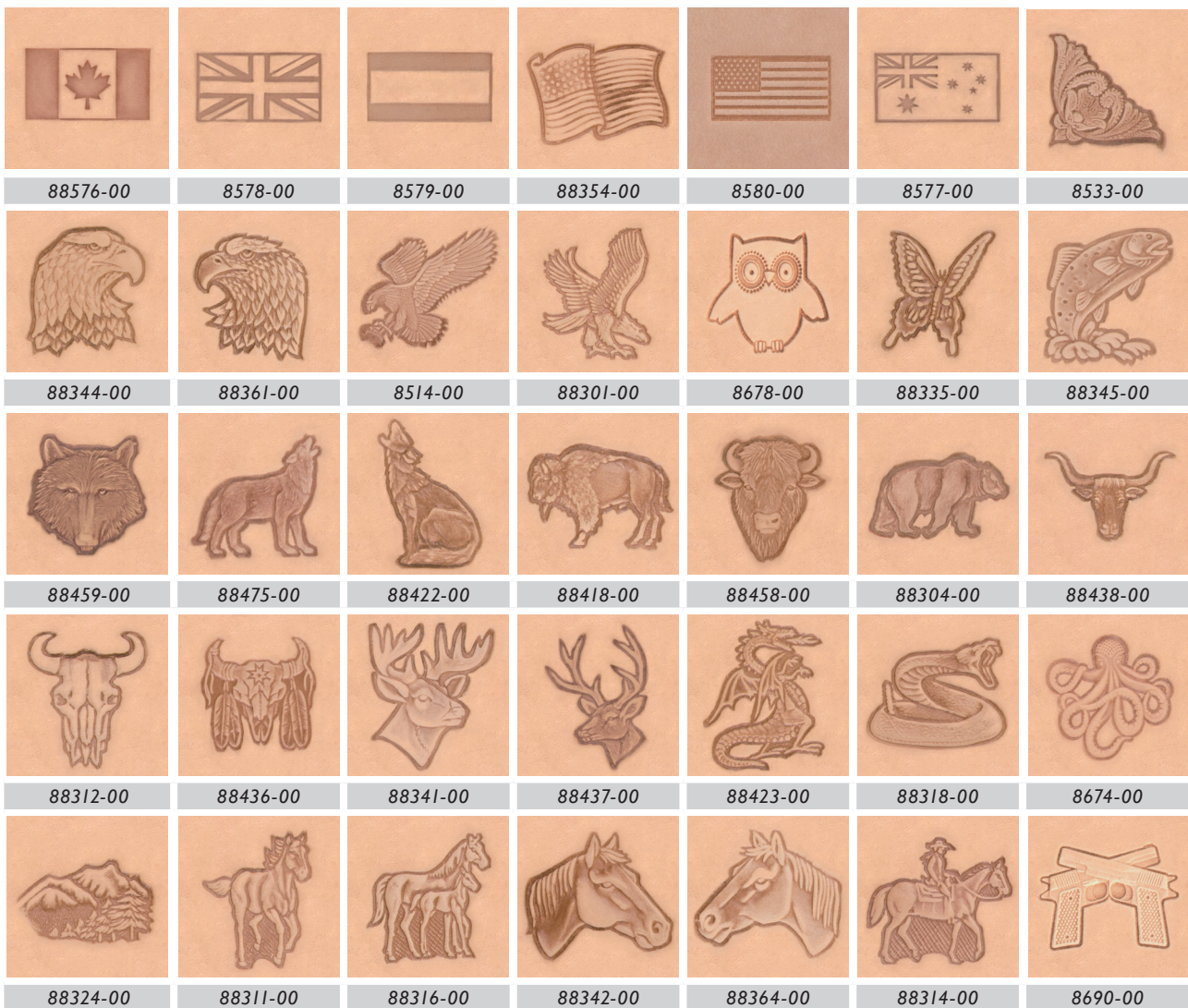



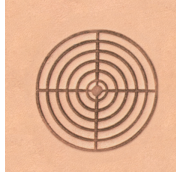
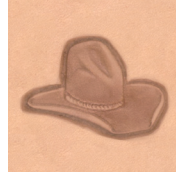
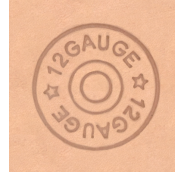
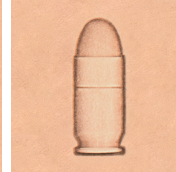
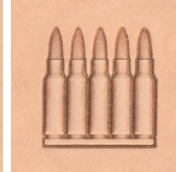
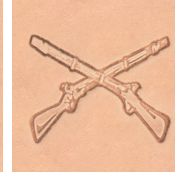
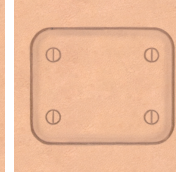
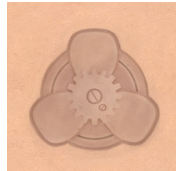
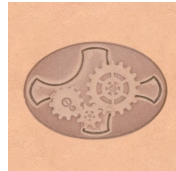

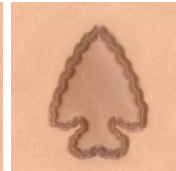

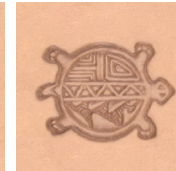

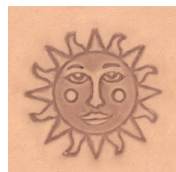

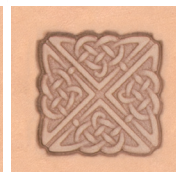
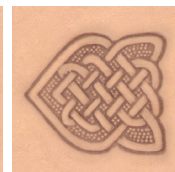
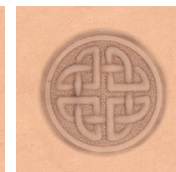
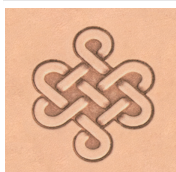
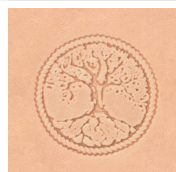
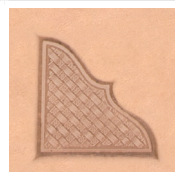

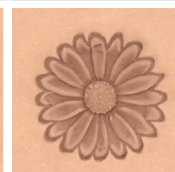





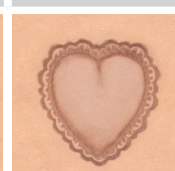

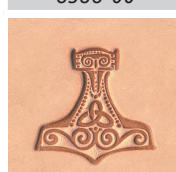

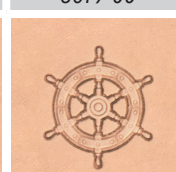

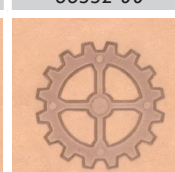



Most items are in inventory and ready to ship. Items mark with "*" are non-stock items, please contact us for quote.



2D & 3D STAMPS

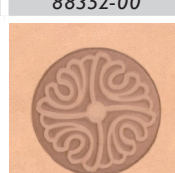

2D & 3D STAMPS

						
8581-00	88470-00	8664-00	8691-00	8582-00	8688-00	8662-00
						
8650-00	8651-00	88502-00	88429-00	88283-00	88286-00	88455-00
						
88489-00	88503-00	88504-00	8684-00	8538-00	88491-00	8537-00
						
8589-00	8686-00	8535-00	8536-00	8534-00	88492-00	88493-00
						
88494-00	8588-00	88575-00	8619-00	8675-00	88332-00	8613-00
						
8590-00	8676-00	8680-00	8682-00	8649-00	8654-00	8547-00
						
8540-00	8671-00	88352-00	8663-00	88566-00	8689-00	88352-00
						
8645-00	8655-00	8660-00	8646-00	8648-00	8647-00	8618-00

2D & 3D STAMPS

						
8352-00	8324-00	8322-00	8325-00	8321-00	8323-00	8367-00
						
8329-00	8330-00	8327-00	8226-00	8220-00	8303-00	8302-00
						
8251-00	8252-00	8253-00	8254-00	8376-00	8371-00	8205-00
						
8261-00	8343-00	8342-00	8341-00	8335-00	8333-00	8334-00
						
8336-00	8337-00	8332-00	8331-00	8340-00	8338-00	8223-00
						
8550-00	8561-00	8666-00	88369-00	8267-00	8266-00	8363-00
						
8361-00	88512-00	8687-00	88331-00	88338-00	8614-00	

SIZING:

The sizing information refers to the height and width of the stamp. The actual pattern size is smaller and may vary depends on the style, design, typical tolerance and measuring instruments.

AVAILABILITY:

Most items are in inventory and ready to ship. Items mark with "*" are non-stock items, please contact us for quote.

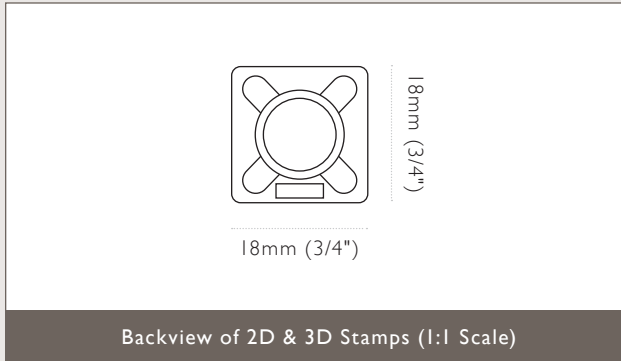

MINI 2D & 3D STAMPS

8800-00	8801-00	8802-00	8803-00	8804-00	8805-00	8806-00
8807-00	8808-00	8809-00	8810-00	8811-00	8812-00	8813-00
8814-00	8815-00	8816-00	8817-00	8818-00	8819-00	8820-00
8821-00	8822-00	8823-00	8824-00	8825-00	8826-00	8827-00
8828-00	8829-00	8830-00	8831-00	8832-00	8833-00	8834-00

MINI 2D & 3D STAMPS

						
8835-00	8836-00	8837-00	8838-00	8839-00	8840-00	8841-00
						
8842-00	8843-00	8844-00	8845-00	8846-00	8847-00	8848-00
						
8849-00	8850-00	8851-00	8852-00	8853-00	8854-00	8855-00
						
8856-00	8857-00	8858-00	8859-00	8860-00	8861-00	8862-00
						
8863-00	8864-00	8865-00	8866-00	8867-00	8868-00	8869-00
						
8870-00	8871-00					





革工佳®多功能皮革手壓機
CRAFTPLUS® MULT-PURPOSE LEATHER HAND PRESS

「佳工」牌「革工佳」多功能皮革手壓機，榮獲「2017年中國設計獎」及「2017年中國設計獎」金獎。該產品採用優質材料，經久耐用，操作簡便，是您手工藝愛好者的最佳選擇。

Introducing a general designer award that has been selected by the Chinese Design Awards Committee. The award is given to the best design in the world. The award is given to the best design in the world. The award is given to the best design in the world.

榮獲「2017年中國設計獎」金獎
榮獲「2017年中國設計獎」金獎
榮獲「2017年中國設計獎」金獎

AWARD WINNER 2017
SILVER AWARD
AWARD WINNER 2017
SILVER AWARD
AWARD WINNER 2017
SILVER AWARD

可調節式壓機
Adjustable Ram Height
適應不同厚度的皮革
Adjustable for different
leather thicknesses, sizes & colors.

打洞
Punch Holes
適用於各種厚度的皮革
Suitable for punching holes
with customized punch
size adapters. (Adapters
sold separately)

鑲嵌五金
Set Hardware
鑲嵌各種五金配件
Set inlays, rivets, grommets,
etc. in leather & fabric.

印花
Stamp Designs
印花各種圖案
Stamp various designs
on leather & fabric.

組裝容易
Easy to Assemble
只需幾分鐘即可組裝
只需幾分鐘即可組裝

實用擴充功能
Add-Ons
可選購各種擴充功能
可選購各種擴充功能

可選購各種擴充功能
可選購各種擴充功能
可選購各種擴充功能

最佳手工藝品
Best Handmade Goods
最佳手工藝品
最佳手工藝品

最佳手工藝品
Best Handmade Goods
最佳手工藝品
最佳手工藝品

最佳手工藝品
Best Handmade Goods
最佳手工藝品
最佳手工藝品

craft
BITLET SETTING DIES
craft
BITLET SETTING DIES

craft+plus[®]

MACHINERY 2019

本目錄所刊登之商品樣式、設計、規格等可能不經預告即行變更。圖片經印刷可能與實際產品顏色、材質有所差異；以實際販售商品為準。所刊登之內容包括文字、印刷或照片錯誤，本公司恕不負責。CRAFTPLUS 保留更新內容之權利，恕不另行通知。

THE STYLE, DESIGNS AND SPECIFICATIONS OF THE PRODUCTS PUBLISHED MAY BE CHANGED WITHOUT NOTICE. THE PRINTED IMAGES MAY DIFFER FROM THE ACTUAL PRODUCT. THE COMPANY IS NOT RESPONSIBLE FOR ANY TYPOGRAPHICAL OR PHOTOGRAPHIC ERRORS. CRAFTPLUS RESERVES THE RIGHTS TO UPDATE THE CONTENT WITHOUT PRIOR NOTICE.

COPYRIGHT © 2019 IVAN LEATHERCRAFT CO., LTD ALL RIGHTS RESERVED.